

Publishing Tasks

The DRAW TABLE tool can be used to create detailed publishing documents. This is where you layout a page into blocks and insert text and/or graphics into those blocks. To illustrate Word's publishing capabilities the following document will be created.

**PARRY AND SYKES
REAL ESTATE**

This Week's Specials

HIGHTON
Just listed this sound home offers 4 good-sized bedrooms, comfortable lounge, central kitchen, plus family room. Excellent parking makes this a most appealing home. Call now for your inspection.
Asking only \$328,000

BELMONT
Delightful BV home in a most pleasant street, featuring 3 bedrooms each with BIR, study, updated kitchen, tastefully decorated lounge with a northerly aspect. Your inspection is highly recommended.
Priced to sell at \$308,000

HIGHTON
Low maintenance home in a quiet court handy to the Highton Shopping Centre. Very good condition inside and out with many internal improvements. New carpets, well established garden and double garage.
Special price \$432,500

BELMONT
Beautifully presented 3 BR home of 14 squares. All gas appliances, BIR in each bedroom, bathroom with vanity unit and separate shower recess. Outside there is a well established garden and double garage.
Reduced to \$276,000

225 High Street, Belmont, Phone 0352 43 8852
AH Graeme Parry 0410 489259, Rebecca Sykes 0410 560389

The Thumbnail Sketch

Whenever you embark on a publishing task some prior planning of what you want your page to look like is necessary. Usually a rough sketch of the page is drawn on paper showing where you intend to place the text and graphics frames (cells). This sketch is called a THUMBNAIL SKETCH. A THUMBNAIL SKETCH (Table Layout) for the page you are about to create is shown below.

In this case you will be creating an A4 paper document. The measurements of the page are 21.0 cm across and 29.7 cm down. If you set TOP and BOTTOM margins of 3.0 cm and LEFT and RIGHT margins of 3.0 cm, the work area will be 15.0 cm across and 23.7 cm down. The cells that will contain data are labelled in the TABLE LAYOUT diagram.

Page Margins

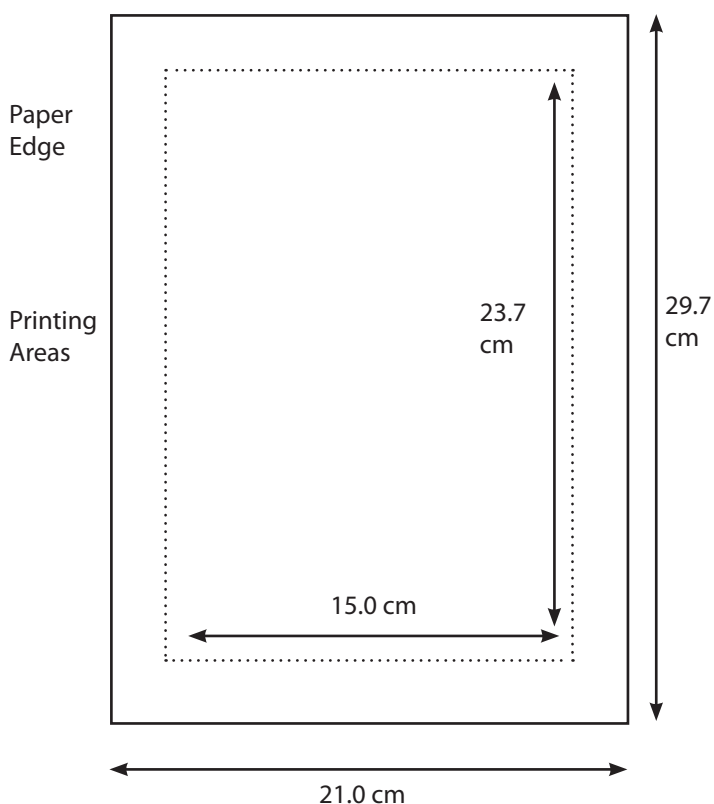
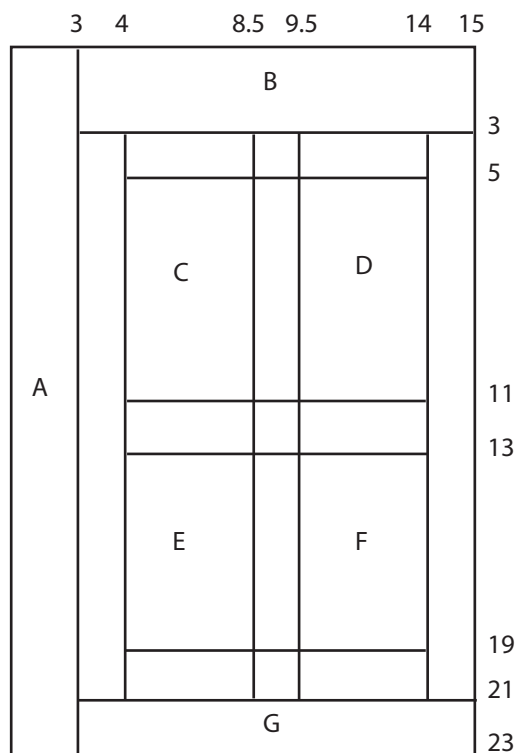

Table Layout



Page Setup

Before starting the publication the paper size and page margins need to be set.

- 1 Load Microsoft Word or close the current file and start a NEW BLANK DOCUMENT.
- 2 Set the screen to PRINT LAYOUT view.
- 3 Display the FILE menu and select PAGE SETUP.

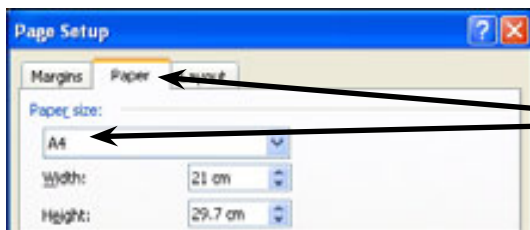

4 Click on the PAPER tab check that the PAPER SIZE box is set to A4 or A4 Letter.

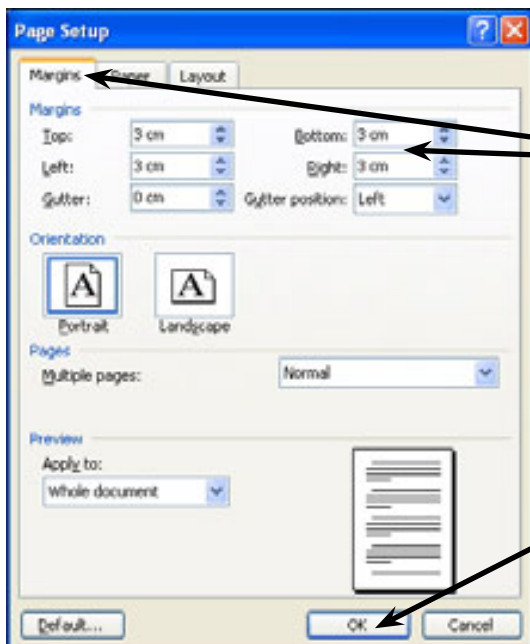

5 Click on the MARGINS tab and set the TOP and BOTTOM, LEFT and RIGHT margins to 3.0 cm.

6 Select OK to return to the document.

Laying out the Page

The first step in creating this type of publication is to place the cells in the required positions in the table.

A Setting the Screen Views

To assist with the laying out of the page the screen will be set to a reduced view, the TABLES AND BORDERS Toolbar will be turned on and text boundaries displayed.

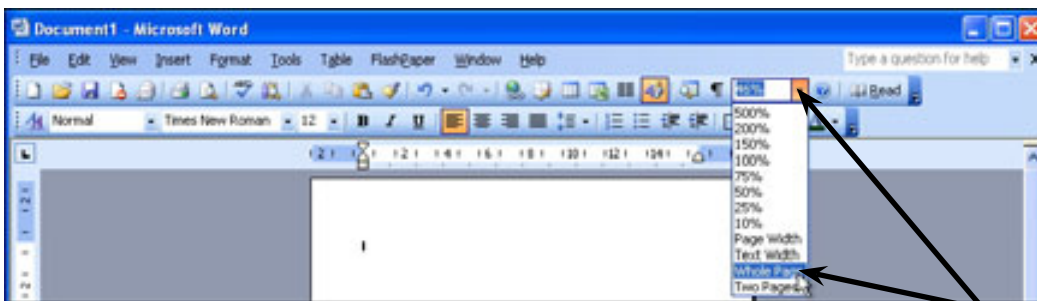

1 Display the ZOOM box in the STANDARD Toolbar and select WHOLE PAGE.

NOTE: The WHOLE PAGE setting reduces the view so that the whole document can be seen on your screen.

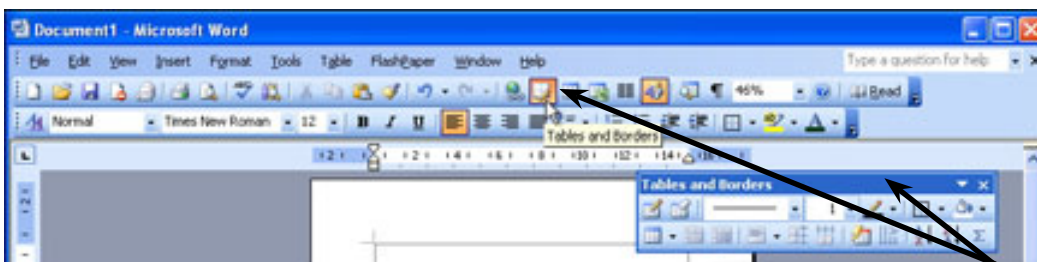

2 Turn on the TABLES AND BORDERS Toolbar and move it to the top right of the screen.

3 It is also handy to turn on TEXT BOUNDARIES so that you can see an outline of the page. Display the TOOLS menu and select OPTIONS.

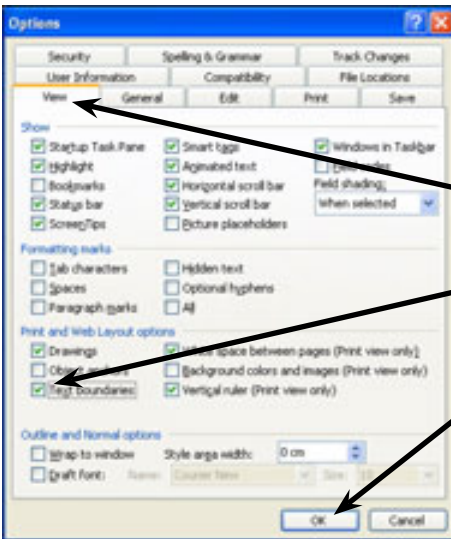

4 In the VIEW tab turn on TEXT BOUNDARIES in the PRINT AND WEB LAYOUT OPTIONS, then select OK.

B Drawing the Table

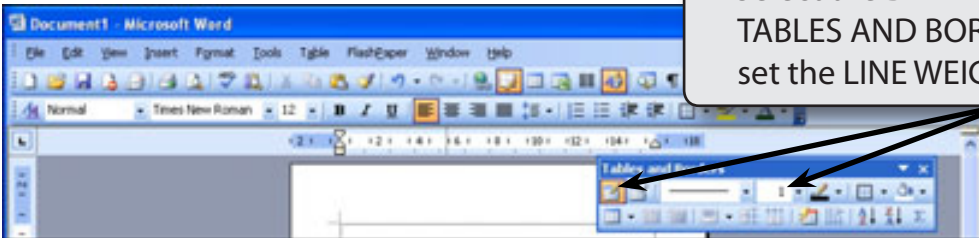

1 Select the DRAW TABLE tool from the TABLES AND BORDERS Toolbar and set the LINE WEIGHT box to 1 pt.

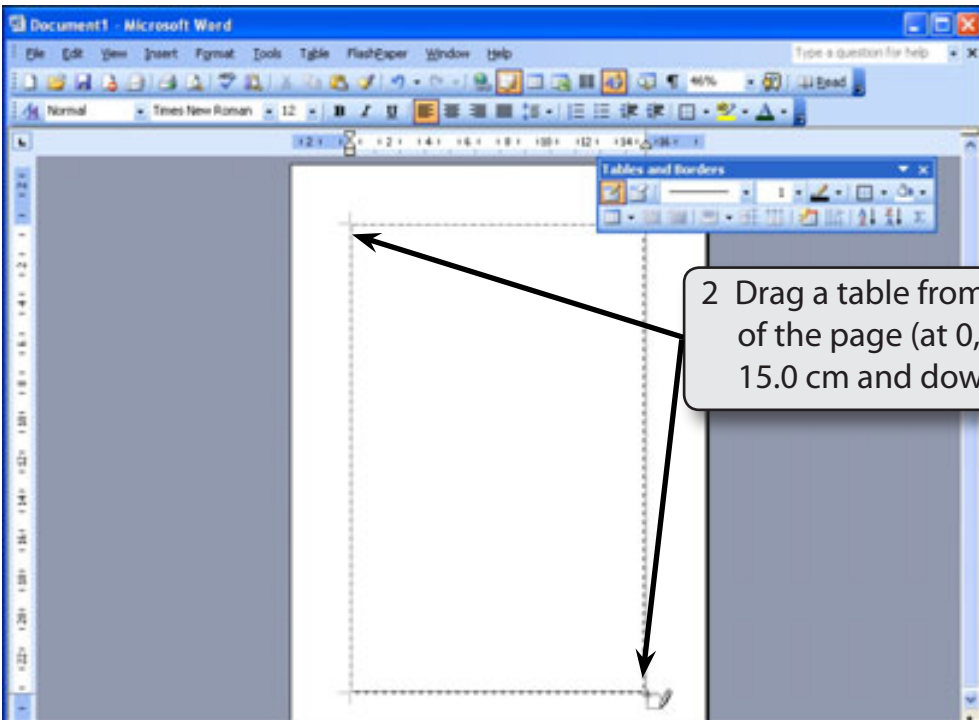

2 Drag a table from the top left corner of the page (at 0,0) across to 15.0 cm and down to 23.0 cm.