

Text Formatting

InDesign offers a full set of word processing features very similar to those found in Microsoft Word. In this chapter we will look at Indents and Tabs which are a vital part of any publishing process and they should be regularly used to ensure that text is aligned correctly. The space bar should never be used to align text.

Starting a New Document

- 1 Load Adobe InDesign or close the current file.
- 2 Select DOCUMENT from the CREATE NEW section of the START SCREEN to start a new document.

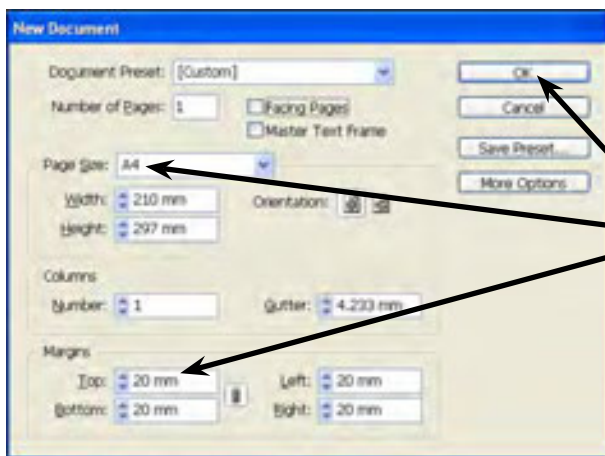

- 3 Set the PAPER SIZE to A4, the MARGINS to 20 mm and turn off FACING PAGES as only a one-page document will be created. Select OK to start the page.

Setting Indents

- 1 Select the TEXT TOOL and drag a text frame around the whole page.
- 2 Set the screen to ACTUAL SIZE (CTRL+1 or COMMAND+1) and enter the following text, pressing the <enter> key only when indicated.

A desktop publishing program is used to combine text and graphics in an appealing way. Adobe InDesign gives you enormous power over the appearance of your creations allowing you to produce professional publications such as newsletters, greeting cards, restaurant menus, books, flyers, web pages and interactive materials.

<enter>

<enter>

A Setting a First Line Indent

Sometimes you need to indent the first line of a paragraph. To avoid having to do this manually you can set an indent to carry out the task automatically.

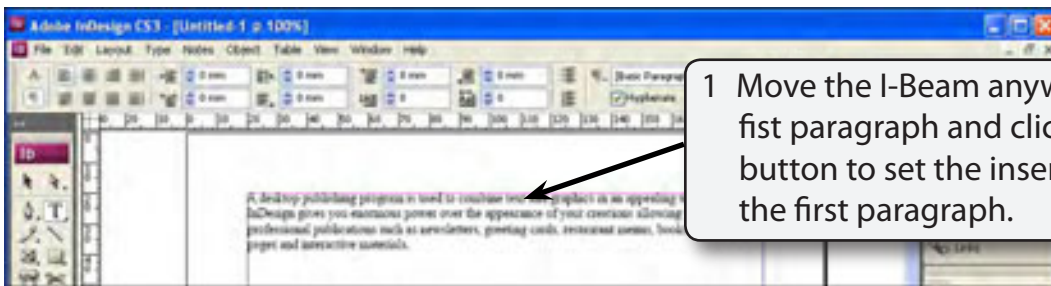

- 2 Display the TYPE menu and select TABS to display the TABS panel. The following diagram labels the sections of the TABS panel.

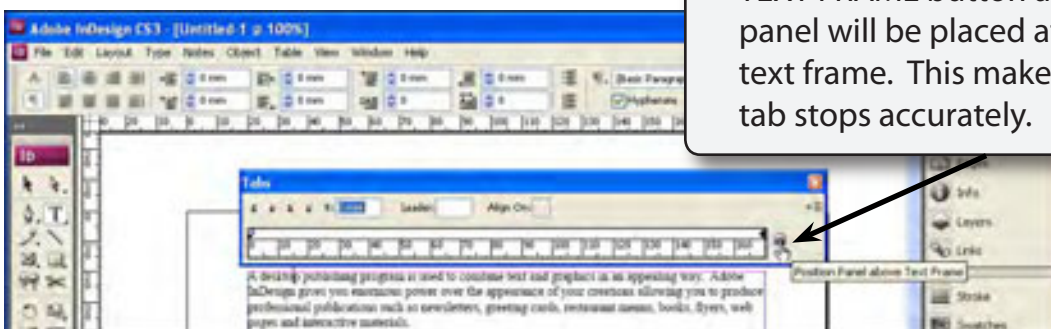
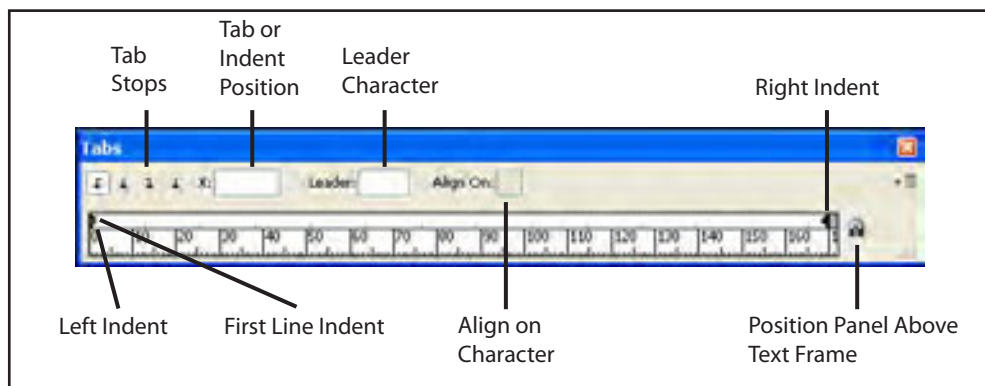

NOTE: There must be enough space above the text frame for the TABS panel to fit. If the TABS panel doesn't jump to the top of the text frame, scroll the screen down a little and try again.



NOTE: The value that you move the marker to is displayed in the POSITION (X) box. The first paragraph should be indented.

B Setting a Hanging Indent

Numbered points will be added below the first paragraph. These points will need their text aligned at the left indent. This is called creating a HANGING INDENT. To create a hanging indent you move the LEFT INDENT marker to the right.

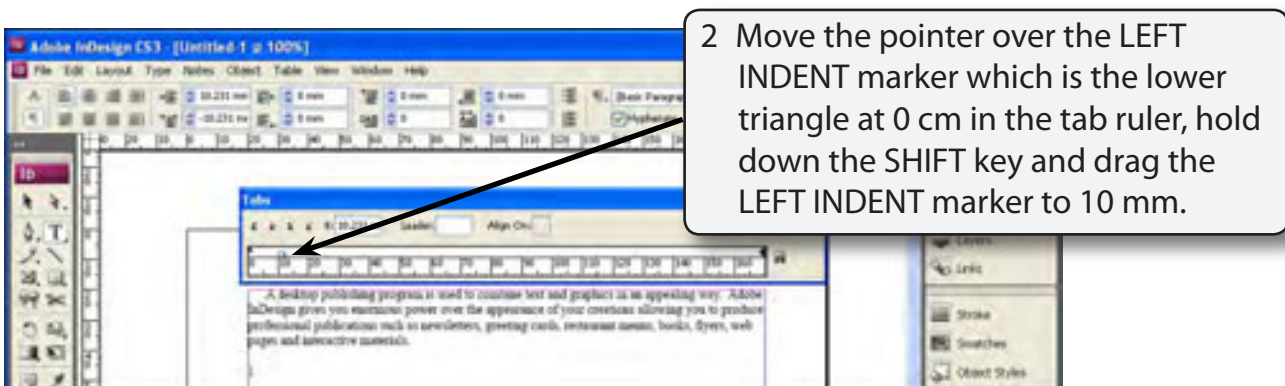
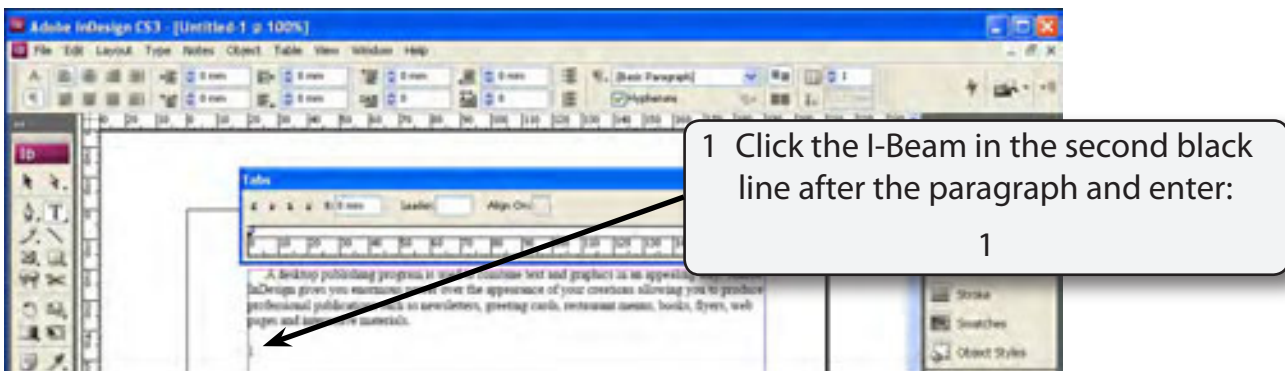

NOTE: The SHIFT key allows just the lower triangle marker to be moved. If you don't hold down the SHIFT key, both triangle markers are moved.

- 3 Press the TAB key to move the insertion point marker to the LEFT INDENT marker and enter:

Adobe InDesign is easy to learn and it is used by authors, publishers, advertising agencies, journalists and students. <enter>

<enter>

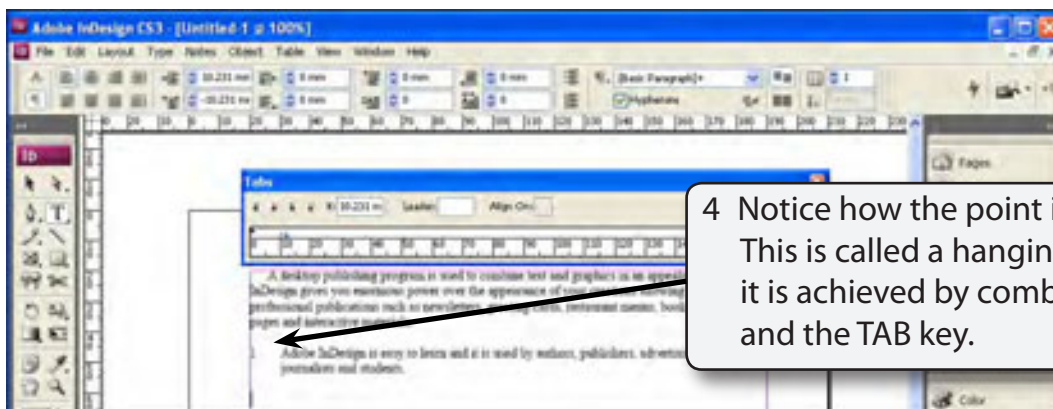

- 5 Enter: 2 press the TAB key and enter:

It is a very versatile and well developed program which has gained wide-spread approval from users involved in the publishing process. <enter>

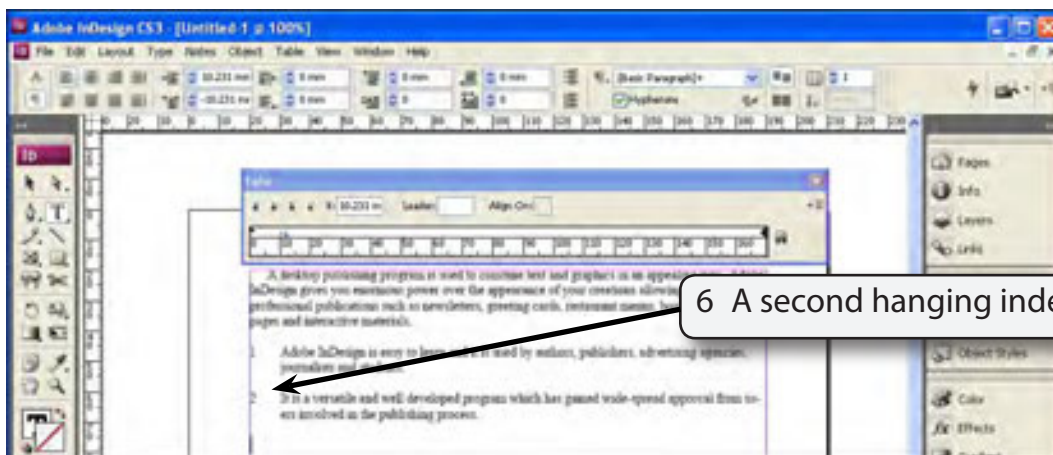

- 7 Save the document in your STORAGE folder as CHAPTER 3

C Changing Indents

An indent can be easily changed once it has been created.

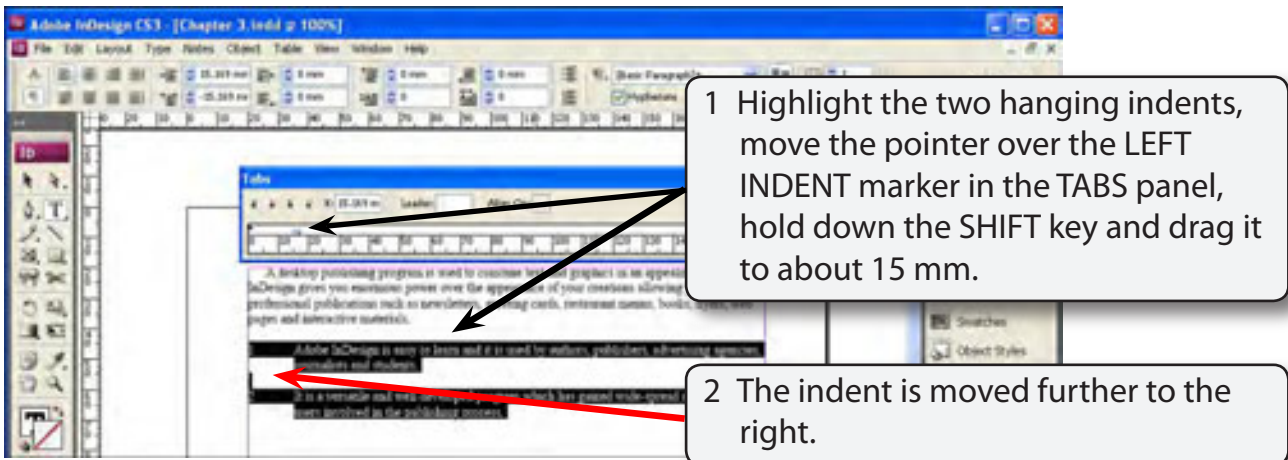

- 3 Move the LEFT INDENT marker back to 10 mm.

D Adjusting Indents Using the Control Panel

The CONTROL panel can also be used to alter some of the indents.

- 1 The two hanging indents should still be highlighted.
- 2 Click on the PARAGRAPH FORMATTING CONTROLS button at the left of the CONTROL panel and notice that the 10 mm LEFT INDENT is displayed. There is also a -10 mm in the FIRST INDENT box to indicate that this paragraph is 10 mm to the left of the FIRST INDENT set for the first paragraph. The following diagram labels the Indent sections of the PARAGRAPH FORMATTING CONTROLS.

